

**SEGREGATION / BOUNDARY LINE  
ADJUSTMENT SURVEY  
PORTIONS OF SECTION 16 & 17  
TOWNSHIP 17 NORTH, RANGE 18 EAST, W.M.,  
KITITAS COUNTY, WASHINGTON.**

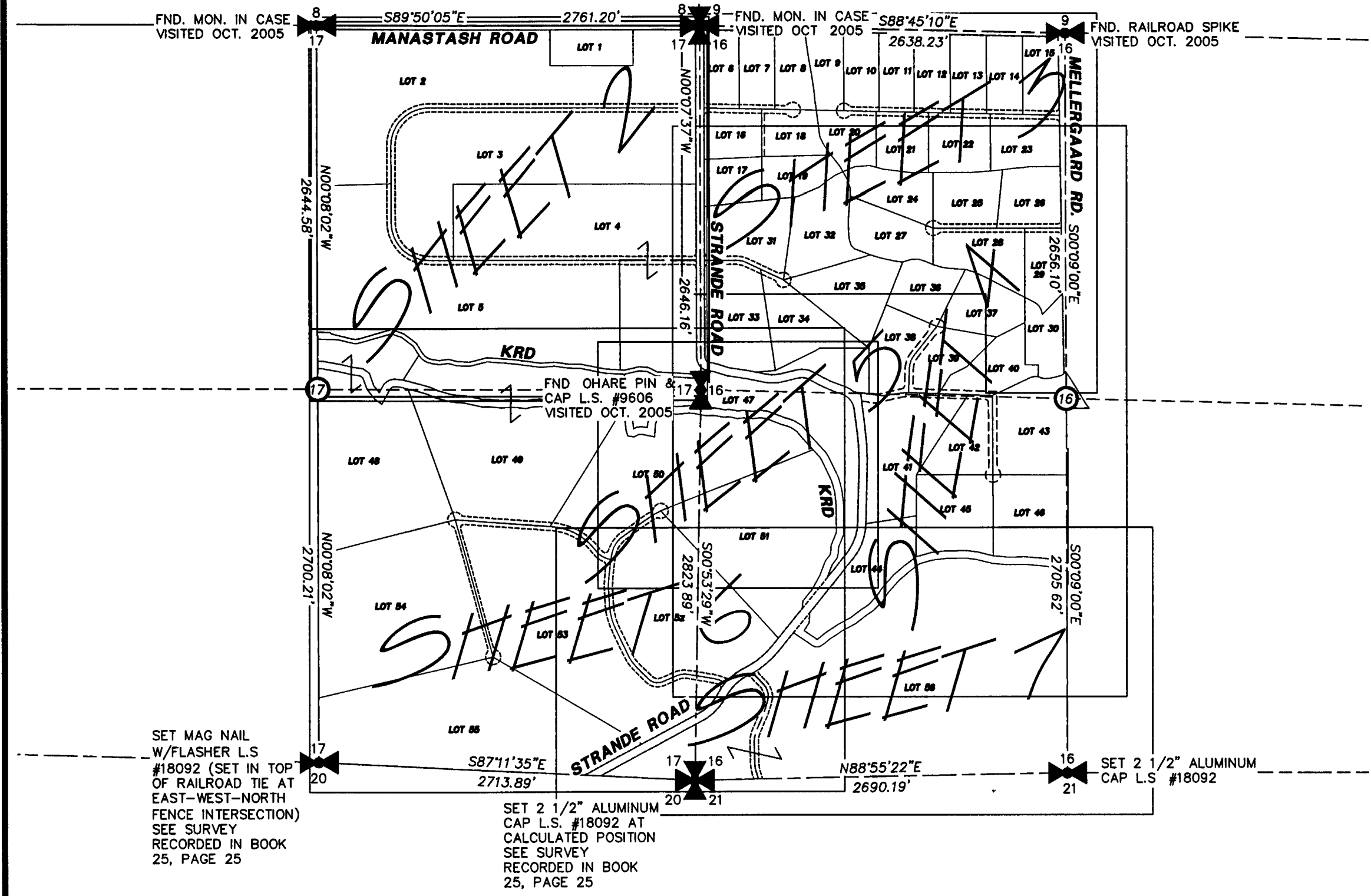

**NOTES:**

1. THE PURPOSE OF THIS SURVEY IS TO PREPARE A MAP SHOWING PARCELS CREATED THROUGH EXEMPT SEGREGATION AND BOUNDARY LINE ADJUSTEMENT. IT WAS NOT WITHIN THE SCOPE OF THIS PROJECT TO SET THE LOT CORNERS FOR THE PARCELS CREATED.
2. THIS SURVEY WAS PERFORMED USING A NIKON DTM-522 TOTAL STATION & A TRIMBLE R8 DUAL FREQUENCY RECEIVER USING RTK METHOD. THE CONTROLLING MONUMENTS AND PROPERTY CORNERS SHOWN HEREON WERE LOCATED AND CHECKED FROM A CLOSED FIELD TRAVERSE IN EXCESS OF 1:10,000 LINEAR CLOSURE AFTER AZIMUTH ADJUSTMENT.
3. THIS SURVEY DOES NOT PURPORT TO SHOW ALL EASEMENTS OF RECORD OR OTHERWISE.
4. FOR SECTION SUBDIVISION, CORNER DOCUMENTATION AND ADDITIONAL SURVEY INFORMATION, SEE BOOK 19 OF SURVEYS AT PAGE 53 AND BOOK 20 OF SURVEYS AT PAGE 15 AND THE SURVEYS REFERENCED THEREON.
5. ALL EASEMENT RADII ARE 25' UNLESS OTHERWISE SPECIFIED.
6. THIS SURVEY SUPERCEDES THAT CERTAIN SURVEY AS RECORDED IN BOOK 32 OF SURVEYS AT PAGES 55-62, UNDER AUDITOR'S FILE No. 200602080004, RECORDS OF KITITAS COUNTY, STATE OF WASHINGTON.

**EXISTING LEGAL DESCRIPTION:**

AFN: 477765 AND 485830

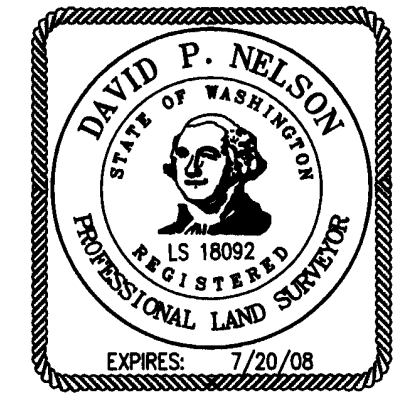

**LEGEND**

- SECTION CORNER COMMON TO FOUR SECTIONS
- QUARTER CORNER COMMON TO TWO SECTIONS

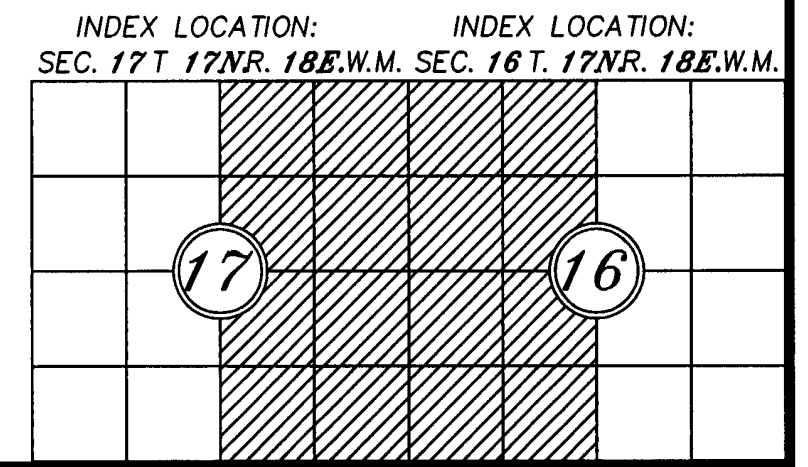
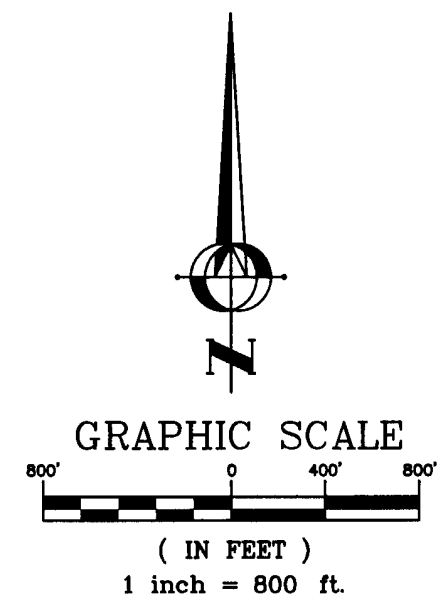

RECORDER'S CERTIFICATE 200612210061  
 Filed for record this 21st day of Dec, 2006 at 1:25 PM in book 35 of Surveys at page 171 at the request of  
DAVID P. NELSON  
 Surveyor's Name  
JERALD V. PETTIT  
 County Auditor  
Katharine Ward  
 Deputy County Auditor

SURVEYOR'S CERTIFICATE  
 This map correctly represents a survey made by me or under my direction in conformance with the requirements of the Survey Recording Act at the request of LAURIN MELLERGAARD in DEC, 2006.  
David P. Nelson  
 DAVID P. NELSON  
 DATE 12/21/06  
 Certificate No. 18092

**Encompass**  
 ENGINEERING & SURVEYING  
 108 EAST 2ND STREET  
 CLE ELUM, WA 98922  
 PHONE: (509) 674-7433  
 FAX: (509) 674-7419

SEGREGATION/BOUNDARY LINE ADJUSTMENT		
PREPARED FOR <b>LAURIN MELLERGAARD</b> PORTIONS OF SEC. 16 & 17 TOWNSHIP 17 NORTH, RANGE 18 EAST, W.M. KITITAS COUNTY WASHINGTON		
DWN BY <b>M. FAIOLA</b>	DATE <b>12/2006</b>	JOB NO. <b>03656</b>
CHKD BY <b>D. NELSON</b>	SCALE <b>1"=800'</b>	SHEET <b>1 OF 7</b>

# SEGREGATION / BOUNDARY LINE ADJUSTMENT SURVEY

## PORTIONS OF SECTION 16 & 17, TOWNSHIP 17 NORTH, RANGE 18 EAST, W.M., KITTITAS COUNTY, WASHINGTON.

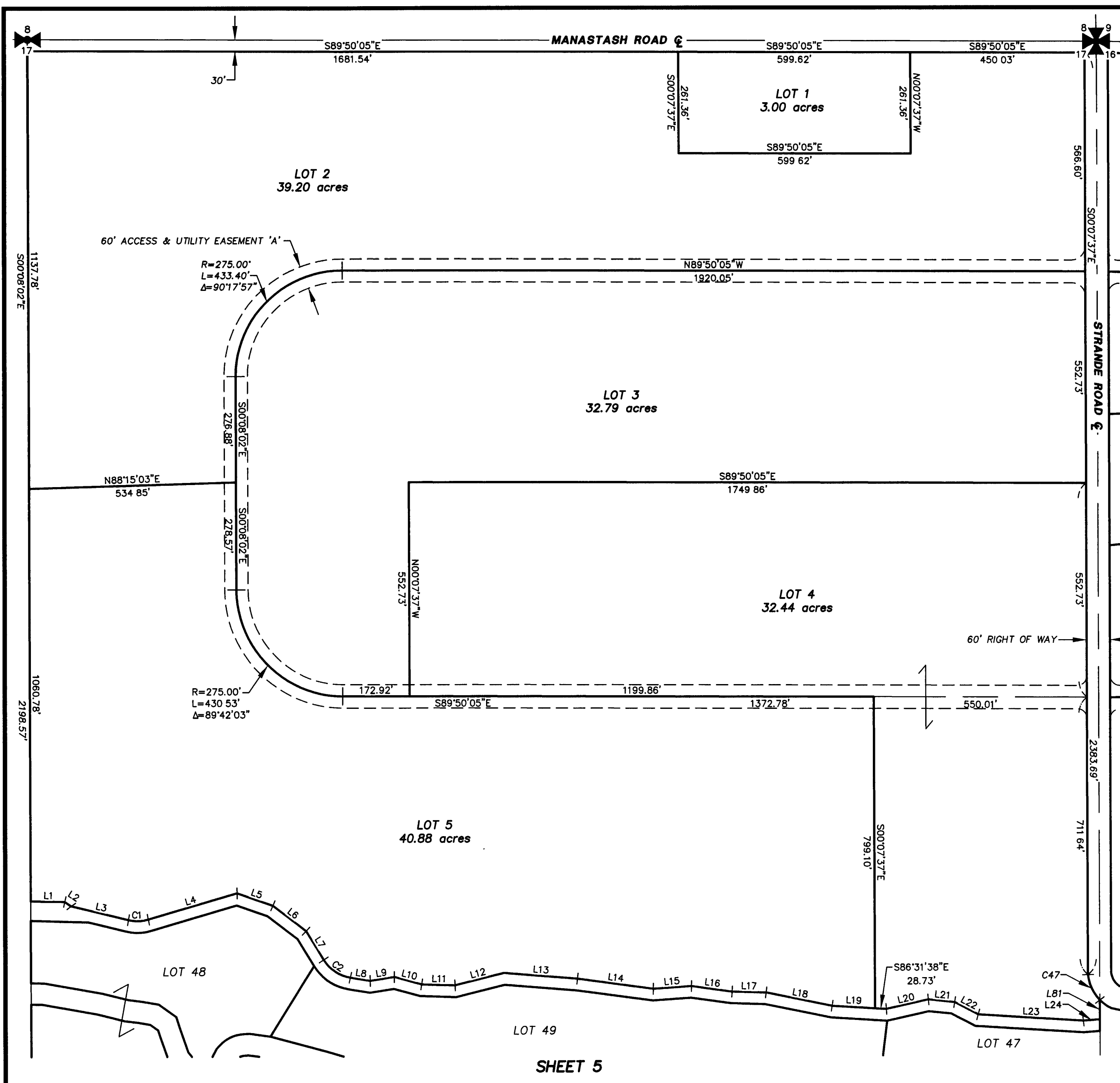

LINE TABLE			CURVE TABLE			
LINE	LENGTH	BEARING	CURVE	LENGTH	RADIUS	DELTA
L1	87.80	S88°54'00"E	C1	51.86	99.60	29°50'00"
L2	20.38	S56°23'29"E	C2	85.18	99.60	49°00'00"
L3	152.02	S76°28'38"E	C47	73.18	105.50	39°44'38"
L4	238.70	N73°41'22"E				
L5	97.15	S70°48'38"E				
L6	108.16	S52°58'38"E				
L7	86.80	S31°48'38"E				
L8	52.05	S80°48'38"E				
L9	62.80	N81°21'22"E				
L10	73.41	S74°53'38"E				
L11	86.18	S88°08'38"E				
L12	130.36	N76°03'22"E				
L13	189.84	S85°26'38"E				
L14	197.87	S82°23'38"E				
L15	99.04	N85°56'22"E				
L16	105.75	S82°03'38"E				
L17	87.45	S88°20'38"E				
L18	175.24	S78°38'38"E				
L19	111.10	S86°31'38"E				
L20	111.30	N77°16'22"E				
L21	68.33	S84°15'38"E				
L22	68.68	S62°25'38"E				
L23	271.78	S86°35'38"E				
L24	42.77	N85°41'22"E				
L81	49.58	N00°07'37"W				

### LEGEND

- SECTION CORNER COMMON TO FOUR SECTIONS
- QUARTER CORNER COMMON TO TWO SECTIONS

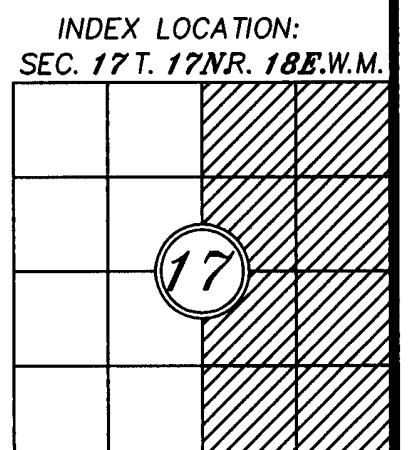
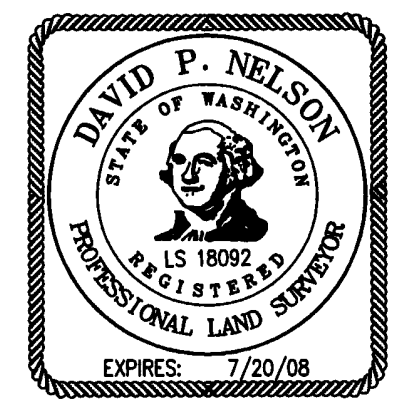
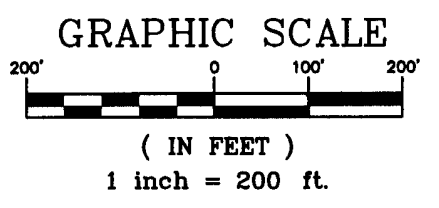

RECORDER'S CERTIFICATE 200612210051  
 Filed for record this 21st day of Dec. 2006 at 4:25 P.M. in book 33 of Surveys at page 172 at the request of  
 DAVID P. NELSON  
 Surveyor's Name  
 JERALD V. PETTIT  
 County Auditor  
 Kristina Wood  
 Deputy County Auditor

SURVEYOR'S CERTIFICATE  
 This map correctly represents a survey made by me or under my direction in conformance with the requirements of the Survey Recording Act at the request of... LAURIN MELLERGAARD... in... DEC... 2006.  
 DAVID P. NELSON  
 DATE 12/21/06  
 Certificate No. 18092

**Encompass**  
 ENGINEERING & SURVEYING  
 108 EAST 2ND STREET  
 CLE ELUM, WA 98922  
 PHONE: (509) 674-7433  
 FAX: (509) 674-7419

SEGREGATION/BOUNDARY LINE ADJUSTMENT		
PREPARED FOR LAURIN MELLERGAARD		
A PORTION OF THE E 1/2 OF SEC. 17 TOWNSHIP 17 NORTH, RANGE 18 EAST, W.M. WASHINGTON		
DWN BY	DATE	JOB NO.
M. FAIOLA	12/2006	03656
CHKD BY	SCALE	SHEET
D. NELSON	1"=200'	2 OF 7

# SEGREGATION / BOUNDARY LINE ADJUSTMENT SURVEY

## PORTIONS OF SECTION 16 & 17, TOWNSHIP 17 NORTH, RANGE 18 EAST, W.M., KITTITAS COUNTY, WASHINGTON.

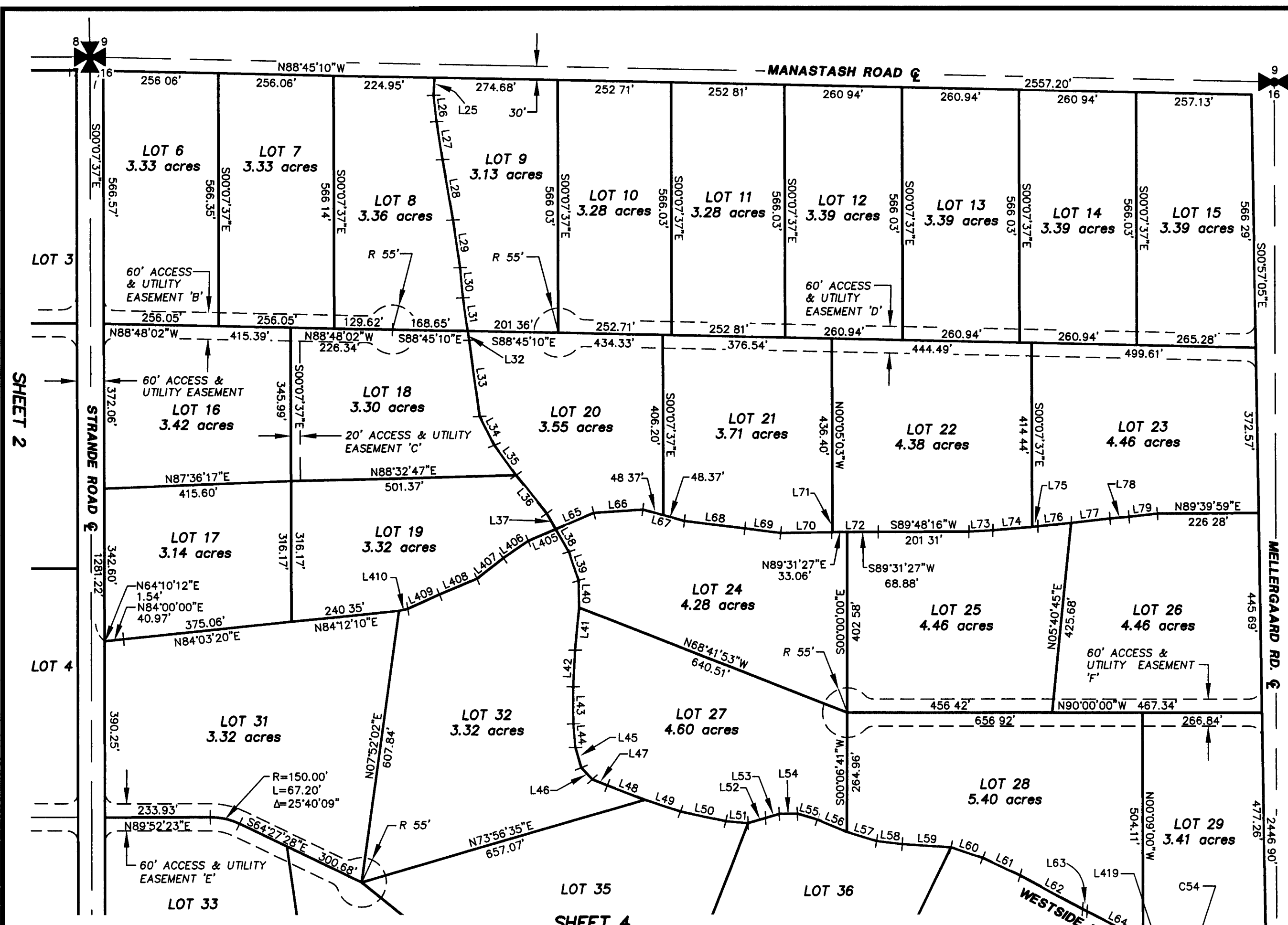

- ### LEGEND
- SECTION CORNER COMMON TO FOUR SECTIONS
  - QUARTER CORNER COMMON TO TWO SECTIONS

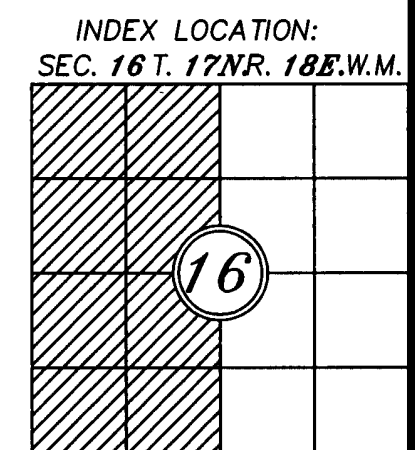
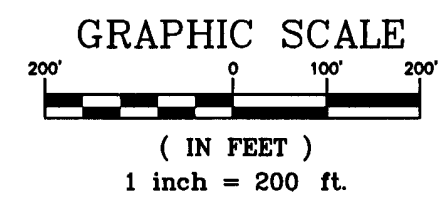
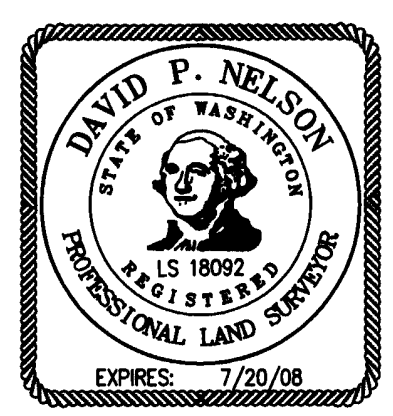

LINE TABLE			LINE TABLE			LINE TABLE			LINE TABLE		
LINE	LENGTH	BEARING	LINE	LENGTH	BEARING	LINE	LENGTH	BEARING	LINE	LENGTH	BEARING
L25	39.65	S02°51'39"W	L45	46.71	S16°04'57"E	L65	91.85	S66°41'03"W	L409	77.32	S65°48'07"W
L26	59.60	S06°35'18"E	L46	35.66	S43°21'38"E	L66	109.07	S86°07'39"W	L410	19.77	S78°08'48"W
L27	85.82	S08°37'52"E	L47	35.72	S67°26'11"E	L67	96.74	N74°38'00"W	L419	77.13	S62°16'54"E
L28	137.82	S09°48'48"E	L48	90.07	S69°11'06"E	L68	134.95	N82°54'18"W	L420	26.39	S14°42'07"E
L29	108.19	S08°30'35"E	L49	83.54	S71°53'50"E	L69	81.03	N82°40'10"W	L421	212.60	N43°34'57"E
L30	67.94	S05°24'44"E	L50	102.62	S77°50'31"E	L70	113.39	S89°16'56"W			
L31	74.33	S08°26'23"E	L51	49.87	S85°09'13"E	L71	1.87	S89°31'27"W			
L32	21.08	S08°26'23"E	L52	40.51	N73°53'16"E	L72	101.94	S89°31'27"W			
L33	173.09	S07°40'09"E	L53	31.95	N73°06'09"E	L73	53.26	S86°47'06"W			
L34	72.74	S26°51'24"E	L54	40.56	N89°27'04"E	L74	88.57	S84°58'31"W			
L35	82.91	S35°24'09"E	L55	46.40	N89°27'04"E	L75	12.41	S84°58'31"W			
L36	109.76	S38°12'53"E	L56	71.51	S67°05'28"E	L76	75.00	S83°56'37"W			
L37	40.88	S29°50'02"E	L57	68.98	S73°06'04"E	L77	86.20	S83°21'24"W			
L38	58.82	S29°50'02"E	L58	56.76	S82°54'44"E	L78	42.15	S85°19'49"W			
L39	68.93	S18°33'41"E	L59	109.01	S86°21'52"E	L79	64.33	S83°27'45"W			
L40	60.76	S01°03'00"E	L60	74.49	S71°39'55"E	L80	40.26	N79°29'53"E			
L41	94.41	S05°26'16"W	L61	91.69	S65°02'19"E	L405	67.24	S66°41'03"W			
L42	81.38	S03°09'42"W	L62	158.12	S61°57'14"E	L406	67.17	S55°09'43"W			
L43	82.46	S00°30'48"E	L63	11.04	S62°53'48"E	L407	75.10	S51°03'17"W			
L44	52.15	S04°50'44"E	L64	139.77	S62°53'48"E	L408	91.40	S67°30'21"W			

CURVE TABLE			
CURVE	LENGTH	RADIUS	DELTA
C42	25.28	135.40	10°41'56"
C43	50.37	100.82	28°37'41"
C44	55.57	315.52	10°05'28"
C45	25.07	79.13	18°09'01"
C54	86.40	99.51	49°45'04"

RECORDER'S CERTIFICATE  
Filed for record this 1st day of Dec. 2006 at 4:25 P.M. in book 22 of Surveys at page 173 at the request of DAVID P. NELSON, Surveyor's Name.  
JERALD V. PETTIT, County Auditor

SURVEYOR'S CERTIFICATE  
This map correctly represents a survey made by me or under my direction in conformance with the requirements of the Survey Recording Act at the request of LAURIN MELLERGAARD in... DEC. 2006.  
DAVID P. NELSON, Surveyor's Name  
Certificate No. 18092

# Encompass

ENGINEERING & SURVEYING

108 EAST 2ND STREET  
CLE ELUM, WA 98922  
PHONE: (509) 674-7433  
FAX: (509) 674-7419

### SEGREGATION/BOUNDARY LINE ADJUSTMENT

PREPARED FOR LAURIN MELLERGAARD  
A PORTION OF THE W 1/2 OF SEC. 16 TOWNSHIP 17 NORTH, RANGE 18 EAST, W.M. WASHINGTON

DWN BY	DATE	JOB NO.
M. FAIOLA	12/2006	03656
CHKD BY	SCALE	SHEET
D. NELSON	1"=200'	3 OF 7

# SEGREGATION / BOUNDARY LINE ADJUSTMENT SURVEY

## PORTIONS OF SECTION 16 & 17, TOWNSHIP 17 NORTH, RANGE 18 EAST, W.M., KITITAS COUNTY, WASHINGTON.

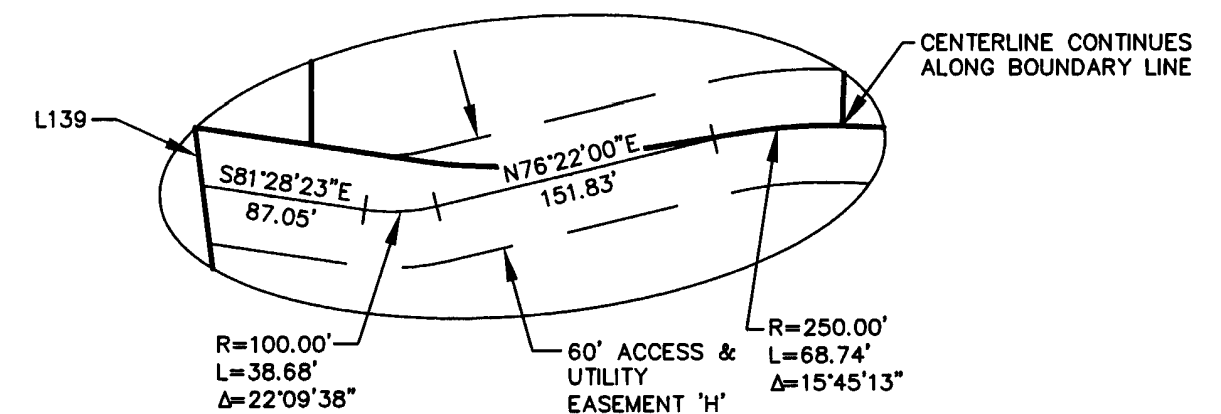
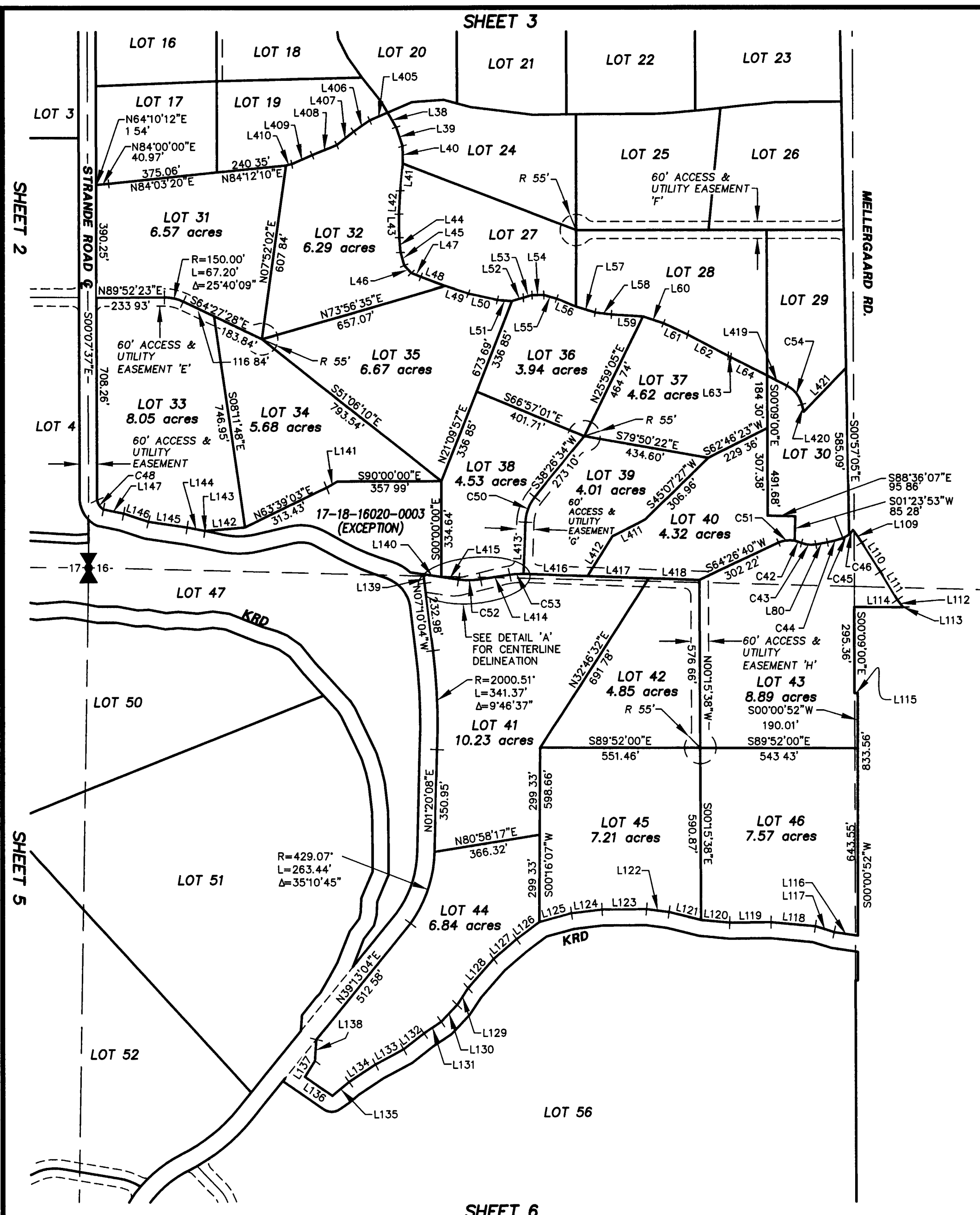

DETAIL 'A'  
SCALE: 1" = 100'

LINE TABLE			LINE TABLE			LINE TABLE		
LINE	LENGTH	BEARING	LINE	LENGTH	BEARING	LINE	LENGTH	BEARING
L38	58.82	S29°50'02"E	L120	98.60	N84°43'00"W	L416	219.89	S87°53'44"E
L39	68.93	S18°33'41"E	L121	114.35	N76°11'00"W	L417	212.31	S87°56'24"E
L40	60.76	S01°03'00"E	L122	77.33	N82°35'00"W	L418	174.45	S87°56'24"E
L41	94.41	S05°26'16"W	L123	154.34	S89°39'00"W	L419	77.13	S82°16'54"E
L42	81.38	S03°09'42"W	L124	105.62	S83°14'00"W	L420	26.39	S14°42'07"E
L43	82.46	S00°30'48"E	L125	114.13	S74°33'00"W	L421	212.60	N43°34'57"E
L44	52.15	S04°50'44"E	L126	98.74	S53°35'00"W			
L45	46.71	S16°04'57"E	L127	103.73	S49°26'00"W			
L46	35.66	S43°21'38"E	L128	132.94	S41°23'00"W			
L47	35.72	S67°26'11"E	L129	68.38	S33°18'00"W			
L48	90.07	S69°11'06"E	L130	79.93	S43°24'00"W			
L49	83.54	S71°53'50"E	L131	71.12	S56°22'00"W			
L50	102.62	S77°50'31"E	L132	89.26	S52°46'00"W			
L51	49.87	S85°09'13"E	L133	109.76	S62°02'00"W			
L52	40.51	N73°53'16"E	L134	108.44	S56°48'00"W			
L53	31.95	N73°06'09"E	L135	74.57	S50°47'00"W			
L54	40.56	N89°27'04"E	L136	113.83	N55°39'00"W			
L55	46.40	S74°02'11"E	L137	65.08	N32°36'00"E			
L56	71.51	S67°05'28"E	L138	72.96	N03°41'00"E			
L57	68.98	S73°06'04"E	L139	31.16	N07°10'04"W			
L58	56.76	S82°54'44"E	L140	62.41	S81°28'23"E			
L59	109.01	S86°21'52"E	L141	44.35	S59°16'42"W			
L60	74.49	S71°39'55"E	L142	138.76	S85°02'05"W			
L61	91.69	S65°02'19"E	L143	0.46	N77°55'18"W			
L62	158.12	S61°57'14"E	L144	62.28	N78°48'31"W			
L63	11.04	S62°53'48"E	L145	134.86	N81°26'36"W			
L64	139.77	S62°53'48"E	L146	90.17	N71°48'04"W			
L80	40.26	N79°29'53"E	L147	71.16	N78°07'14"W			
L109	53.11	S34°41'41"E	L405	67.24	S66°41'03"W			
L110	120.82	S32°16'54"E	L406	67.17	S55°09'43"W			
L111	112.37	S31°05'38"E	L407	75.10	S51°03'17"W			
L112	31.61	S38°13'25"E	L408	91.40	S67°30'21"W			
L113	1.06	S35°28'49"E	L409	77.32	S65°48'07"W			
L114	168.28	N89°39'47"W	L410	19.77	S78°08'48"W			
L115	10.83	S89°39'47"E	L411	127.55	S62°45'09"W			
L116	81.58	N81°38'00"W	L412	162.69	S31°54'33"W			
L117	67.95	N72°43'00"W	L413	180.19	S02°07'13"W			
L118	154.47	N84°43'00"W	L414	101.49	S81°09'04"W			
L119	143.00	S89°26'00"W	L415	59.54	N81°28'23"W			

CURVE TABLE			
CURVE	LENGTH	RADIUS	DELTA
C42	25.28	135.40	10°41'56"
C43	50.37	100.82	28°37'41"
C44	55.57	315.52	10°05'28"
C45	25.07	79.13	18°09'01"
C46	20.68	57.37	20°39'06"
C48	39.91	45.50	50°15'49"
C50	95.09	150.00	36°19'21"
C51	57.42	100.74	32°39'18"
C52	75.82	250.00	17°22'33"
C53	47.86	250.00	10°58'09"
C54	86.40	99.51	49°45'04"

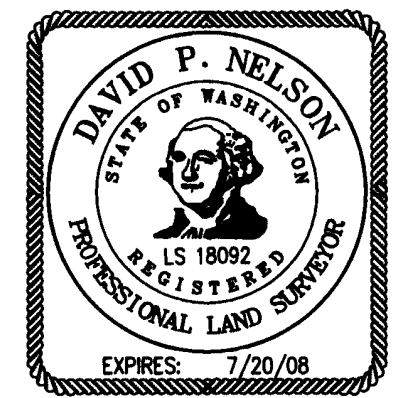

INDEX LOCATION:  
SEC. 16 T. 17N. R. 18E. W.M.

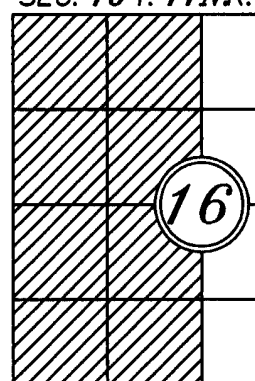

**LEGEND**

✠ SECTION CORNER COMMON TO FOUR SECTIONS

⊕ QUARTER CORNER COMMON TO TWO SECTIONS

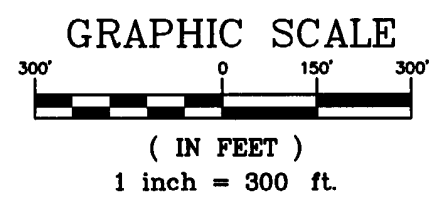

RECORDER'S CERTIFICATE 200612210051  
 Filed for record this 21st day of Dec. 2006 at 4:25 P.M. in book 33 of surveys at page 174 at the request of DAVID P. NELSON, Surveyor's Name.  
 JERALD V. PETTIT, County Auditor

SURVEYOR'S CERTIFICATE  
 This map correctly represents a survey made by me or under my direction in conformance with the requirements of the Survey Recording Act at the request of LAURIN MELLERGAARD in DEC. 2006.  
 DAVID P. NELSON, DATE 12/21/06  
 Certificate No. 18092

**Encompass**  
 ENGINEERING & SURVEYING  
 108 EAST 2ND STREET  
 CLE ELUM, WA 98922  
 PHONE: (509) 674-7433  
 FAX: (509) 674-7419

**SEGREGATION/BOUNDARY LINE ADJUSTMENT**  
 PREPARED FOR  
**LAURIN MELLERGAARD**  
 A PORTION OF THE W 1/2 OF SEC. 16  
 TOWNSHIP 17 NORTH, RANGE 18 EAST, W.M.  
 KITITAS COUNTY WASHINGTON

DWN BY	DATE	JOB NO.
M. FAIOLA	12/2006	03656
CHKD BY	SCALE	SHEET
D. NELSON	1"=300'	4 OF 7



# SEGREGATION / BOUNDARY LINE ADJUSTMENT SURVEY

## PORTIONS OF SECTION 16 & 17, TOWNSHIP 17 NORTH, RANGE 18 EAST, W.M., KITITAS COUNTY, WASHINGTON.

LINE TABLE		
LINE	LENGTH	BEARING
L81	49.58	N00°07'37"W
L167	110.70	N77°16'22"E
L168	57.67	S84°15'38"E
L169	69.32	S62°25'38"E
L170	280.22	S86°35'38"E
L171	42.60	N85°41'22"E
L172	30.08	N00°07'37"W
L173	76.33	S78°07'14"E
L174	91.92	S71°48'04"E
L175	138.54	S81°26'36"E
L176	60.44	S78°48'31"E
L177	61.85	S77°55'18"E
L178	119.20	N76°37'58"E
L179	85.32	S60°56'07"E
L180	52.39	S71°02'18"E
L182	162.42	S07°10'04"E
L183	351.62	S01°20'08"W
L184	239.50	S39°13'04"W
L185	103.04	N21°38'00"E
L186	57.39	N37°21'00"E
L187	38.62	N14°03'00"E
L188	45.25	N02°57'00"E
L189	100.00	N22°53'00"E
L190	85.25	N00°12'00"W
L191	129.90	N00°33'00"W
L192	99.01	N06°24'00"W
L193	53.32	N13°40'00"W
L194	54.62	N17°15'00"W
L195	170.73	N25°31'00"W
L196	29.20	N32°42'00"W
L197	182.01	N42°30'00"W
L198	76.99	N39°16'00"W
L199	57.44	N55°28'00"W
L200	34.42	N66°45'00"W
L201	54.61	N73°11'00"W
L202	123.90	N68°44'00"W
L203	56.76	N82°37'00"W
L204	52.81	S82°45'00"W
L205	66.42	N85°14'00"W
L206	42.11	S84°38'00"W
L207	59.97	N79°08'00"W
L208	40.13	S87°58'00"W
L209	70.32	N79°33'00"W
L210	66.18	N89°49'00"W
L211	38.74	N80°09'00"W
L212	37.75	N80°09'00"W
L213	42.38	N84°53'00"W
L214	94.12	S85°33'00"W
L215	69.26	N82°02'00"W
L216	48.71	S84°42'00"W
L217	48.37	S60°04'00"W
L218	50.31	S32°04'00"W
L219	64.66	S17°08'00"W
L220	30.35	S03°51'00"W
L221	34.93	N77°30'00"W
L222	42.18	S87°21'00"W
L223	25.60	S63°05'00"W
L224	82.83	N05°41'00"W
L225	45.36	N32°20'00"W
L226	39.01	N42°21'00"W
L227	38.17	N64°48'00"W

CURVE TABLE			
CURVE	LENGTH	RADIUS	DELTA
C5	146.56	330.00	25°26'44"
C6	74.06	100.00	42°25'55"
C7	135.71	943.58	8°14'27"
C8	127.48	125.00	58°25'54"
C9	331.79	1940.51	9°47'47"
C10	225.24	369.07	34°58'03"
C49	36.97	105.50	20°04'53"

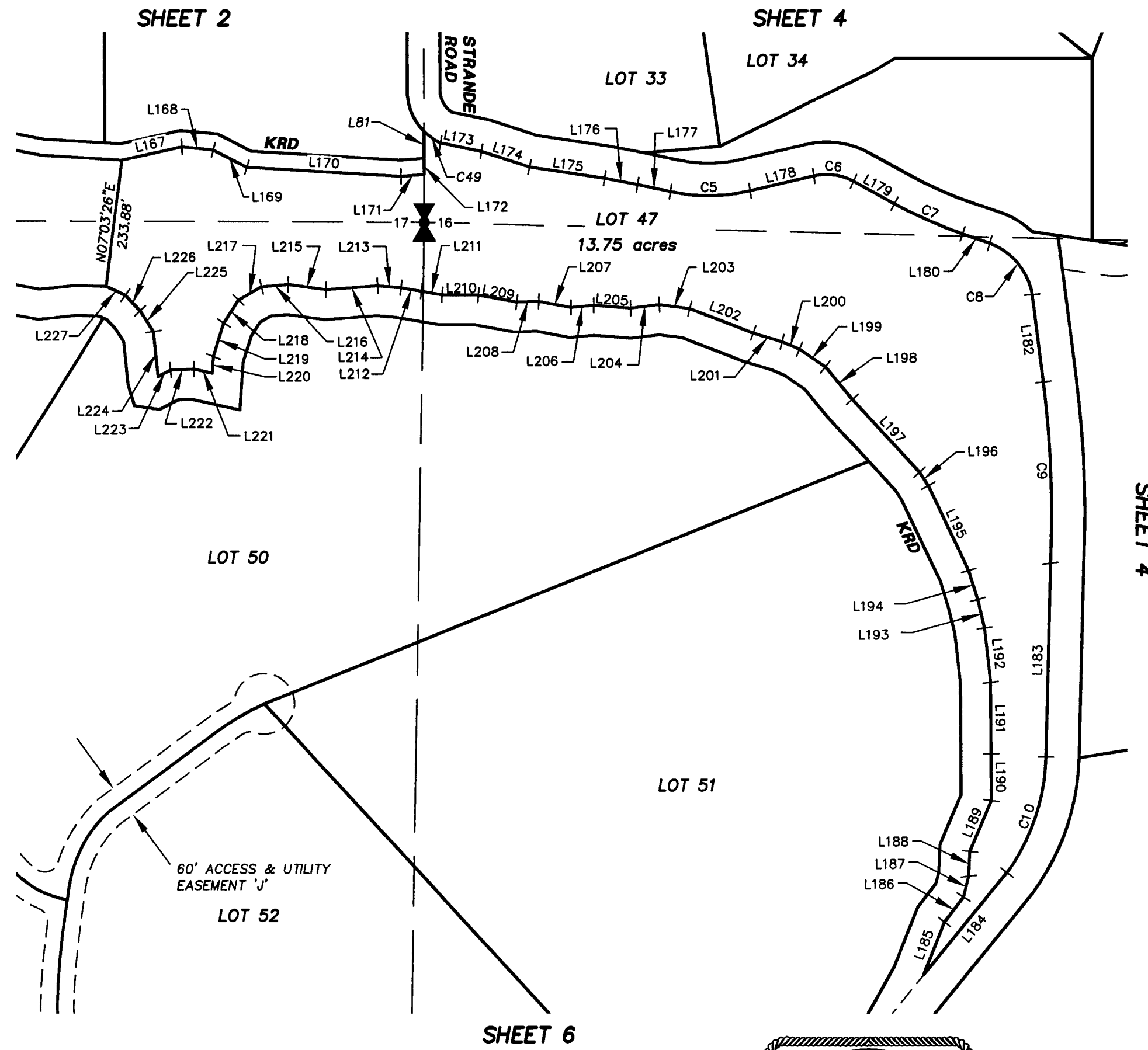

**LEGEND**

SECTION CORNER COMMON TO FOUR SECTIONS  
 QUARTER CORNER COMMON TO TWO SECTIONS

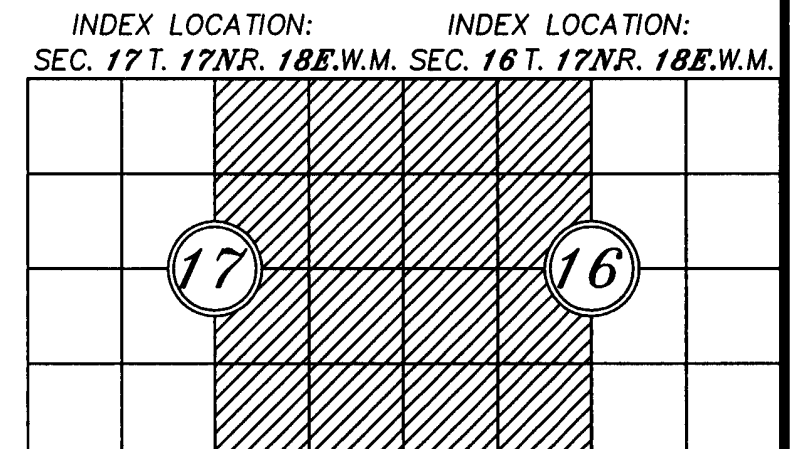
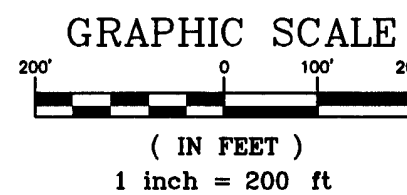
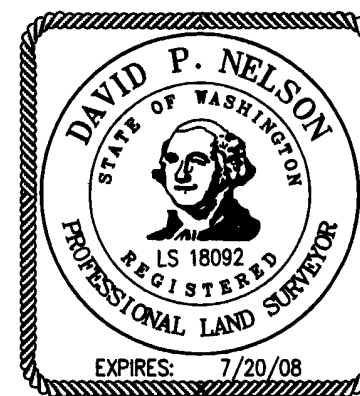

RECORDER'S CERTIFICATE 200612210051

Filed for record this 21st day of Dec. 2006 at 4:25 P.M. in book 33 of Surveys at page 175 at the request of DAVID P. NELSON Surveyor's Name

JERALD V. PETTIT County Auditor      Justin Wood Deputy County Auditor

SURVEYOR'S CERTIFICATE

This map correctly represents a survey made by me or under my direction in conformance with the requirements of the Survey Recording Act at the request of LAURIN MELLERGAARD in DEC. 2006.

David P. Nelson DAVID P. NELSON      12/20/06 DATE

Certificate No. 18092

**Encompass**

ENGINEERING & SURVEYING

108 EAST 2ND STREET  
CLE ELUM, WA 98922  
PHONE: (509) 674-7433  
FAX: (509) 674-7419

SEGREGATION/BOUNDARY LINE ADJUSTMENT		
PREPARED FOR <b>LAURIN MELLERGAARD</b>		
PORTIONS OF THE E 1/2 OF SEC. 17 & THE W 1/2 OF SEC. 16 TOWNSHIP 17 NORTH, RANGE 18 EAST, W.M.		
KITITAS COUNTY      WASHINGTON		
DWN BY	DATE	JOB NO.
<b>M. FAIOLA</b>	<b>12/2006</b>	<b>03656</b>
CHKD BY	SCALE	SHEET
<b>D. NELSON</b>	<b>1"=200'</b>	<b>5 OF 7</b>

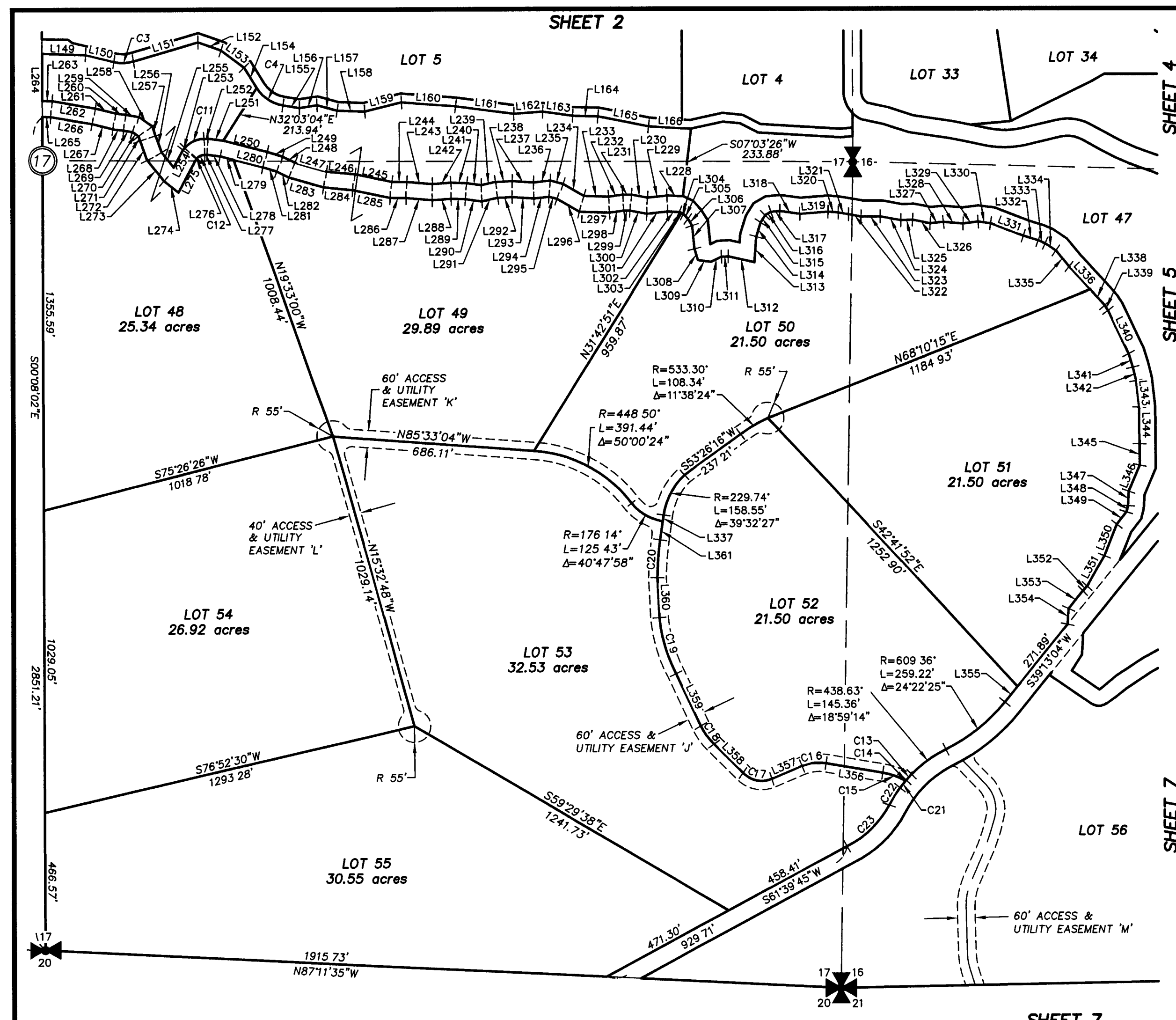

# SEGREGATION / BOUNDARY LINE ADJUSTMENT SURVEY

## PORTIONS OF SECTION 16 & 17, TOWNSHIP 17 NORTH, RANGE 18 EAST, W.M., KITTITAS COUNTY, WASHINGTON.

LINE TABLE			LINE TABLE			LINE TABLE		
LINE	LENGTH	BEARING	LINE	LENGTH	BEARING	LINE	LENGTH	BEARING
L149	148.31	S88°15'38"E	L261	72.09	N76°09'00"W	L312	91.61	S77°30'00"E
L150	99.95	S76°28'38"E	L262	148.99	N79°58'00"W	L313	87.94	N03°51'00"E
L151	229.10	N73°41'22"E	L263	34.35	N89°11'00"W	L314	51.05	N17°08'00"E
L152	82.85	S70°48'38"E	L264	160.20	N00°08'02"W	L315	29.39	N32°04'00"E
L153	97.84	S52°58'38"E	L265	29.00	S89°11'00"E	L316	22.65	N60°04'00"E
L154	81.20	S31°48'38"E	L266	142.72	S79°58'00"E	L317	30.31	N84°42'00"E
L155	56.75	S80°48'38"E	L267	73.52	S76°09'00"E	L318	68.85	S82°02'00"E
L156	61.20	N81°21'22"E	L268	36.76	S82°56'00"E	L319	95.50	N85°33'00"E
L157	70.59	S74°53'38"E	L269	30.96	S80°30'00"E	L320	35.50	S84°53'00"E
L158	93.82	S88°08'38"E	L270	24.74	S54°31'00"E	L321	35.47	S80°09'00"E
L159	129.64	N78°03'22"E	L271	17.71	S17°46'00"E	L322	43.39	S80°09'00"E
L160	184.16	S85°26'38"E	L272	70.59	S19°46'00"E	L323	65.89	S89°49'00"E
L161	200.13	S82°23'38"E	L273	91.54	S38°12'00"E	L324	71.39	S79°33'00"E
L162	98.96	N85°56'22"E	L274	63.50	S51°18'00"E	L325	39.93	N87°58'00"E
L163	104.25	S82°03'38"E	L275	130.76	N27°50'00"E	L326	61.59	S79°08'00"E
L164	86.55	S88°20'38"E	L276	3.05	N41°47'00"E	L327	45.08	N84°38'00"E
L165	174.76	S78°38'38"E	L277	8.52	N88°07'00"E	L328	67.33	S85°14'00"E
L166	146.17	S86°31'38"E	L278	45.09	S82°18'00"E	L329	51.54	N82°45'00"E
L228	55.61	N88°07'00"W	L279	46.91	S75°16'00"E	L330	43.00	S82°37'00"E
L229	66.24	S84°05'00"W	L280	102.49	S75°16'00"E	L331	119.34	S88°44'00"E
L230	55.20	N79°11'00"W	L281	48.91	S73°10'00"E	L332	53.65	S73°11'00"E
L231	29.79	S89°53'00"W	L282	47.16	S63°20'00"E	L333	25.90	S66°45'00"E
L232	48.33	S81°55'00"W	L283	122.73	S74°04'00"E	L334	44.18	S55°28'00"E
L233	83.32	N87°56'00"W	L284	99.65	S84°37'00"E	L335	70.72	S39°16'00"E
L234	82.91	N60°24'00"W	L285	129.81	S77°47'00"E	L336	106.35	S42°30'00"E
L235	46.13	N75°01'00"W	L286	55.29	S89°15'00"E	L337	21.88	S07°50'27"W
L236	57.49	S83°30'00"W	L287	88.83	S85°08'00"E	L338	72.50	S42°30'00"E
L237	72.83	N86°13'00"W	L288	64.48	N86°02'00"E	L339	21.03	S32°42'00"E
L238	56.94	S87°18'00"W	L289	48.94	S87°54'00"E	L340	163.30	S25°31'00"E
L239	49.73	S77°39'00"W	L290	56.56	S82°10'00"E	L341	48.93	S17°15'00"E
L240	49.52	N82°10'00"W	L291	54.87	N77°39'00"E	L342	48.10	S13°40'00"E
L241	54.61	N87°54'00"W	L292	49.18	N87°18'00"E	L343	92.71	S06°24'00"E
L242	63.15	S86°02'00"W	L293	74.67	S86°13'00"E	L344	126.92	S00°33'00"E
L243	86.55	N85°08'00"W	L294	52.01	N83°30'00"E	L345	73.85	S00°12'00"E
L244	51.74	N89°15'00"W	L295	28.64	S75°01'00"E	L346	98.43	S22°53'00"W
L245	127.58	N77°47'00"W	L296	89.34	S60°24'00"E	L347	49.57	S02°57'00"W
L246	97.86	N84°37'00"W	L297	101.68	S87°56'00"E	L348	21.93	S14°03'00"W
L247	112.48	N74°04'00"W	L298	49.38	N81°55'00"E	L349	53.64	S37°21'00"W
L248	46.72	N63°20'00"W	L299	20.69	N89°53'00"E	L350	116.40	S21°38'00"W
L249	54.65	N73°10'00"W	L300	58.03	S79°11'00"E	L351	120.21	S29°25'00"W
L250	153.79	N75°16'00"W	L301	70.58	N84°05'00"E	L352	21.39	S43°15'00"W
L251	53.08	N82°18'00"W	L302	40.51	S88°07'00"E	L353	77.10	S38°35'00"W
L252	13.13	S88°07'00"W	L303	8.53	S64°48'00"E	L354	53.12	S03°41'00"W
L253	9.78	S41°47'00"W	L304	7.37	S64°48'00"E	L355	68.05	S39°13'04"W
L254	68.60	S27°50'00"W	L305	23.28	S42°21'00"E	L356	196.98	N80°34'31"W
L255	66.22	N38°12'00"W	L306	27.51	S32°20'00"E	L357	111.70	S66°51'37"W
L256	60.71	N19°46'00"W	L307	80.22	S05°41'00"E	L358	138.94	N45°00'36"W
L257	35.02	N17°46'00"W	L308	39.54	S16°53'00"E	L359	197.09	N25°30'16"W
L258	55.70	N54°31'00"W	L309	45.02	S81°13'00"E	L360	135.55	N02°57'49"W
L259	44.82	N80°30'00"W	L310	39.14	N63°05'00"E	L361	64.14	N07°50'27"E
L260	34.67	N82°56'00"W	L311	23.04	N87°21'00"E			

CURVE TABLE			CURVE TABLE				
CURVE	LENGTH	RADIUS	DELTA	CURVE	LENGTH	RADIUS	DELTA
C3	67.48	129.60	29°50'00"	C20	131.30	1187.03	6°20'15"
C4	110.84	129.60	49°00'00"	C21	30.34	438.63	3°57'48"
C11	74.64	92.30	46°20'00"	C22	68.87	438.63	8°59'45"
C12	30.16	37.30	46°20'00"	C23	204.65	322.46	36°21'47"
C13	27.18	438.63	3°33'02"				
C14	3.40	438.63	0°26'41"				
C15	82.68	222.74	21°16'01"				
C16	83.03	150.94	31°31'02"				
C17	106.77	87.57	69°51'42"				
C18	76.30	234.16	18°40'11"				
C19	199.30	492.84	23°10'11"				

**LEGEND**

- SECTION CORNER COMMON TO FOUR SECTIONS
- QUARTER CORNER COMMON TO TWO SECTIONS
- CENTER OF SECTION

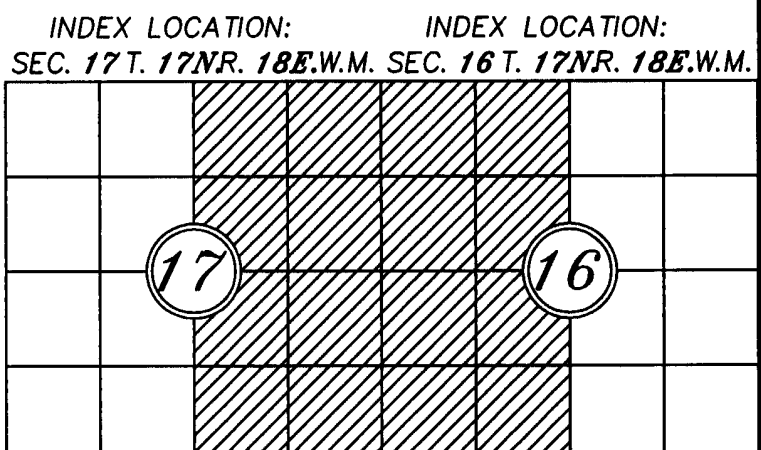
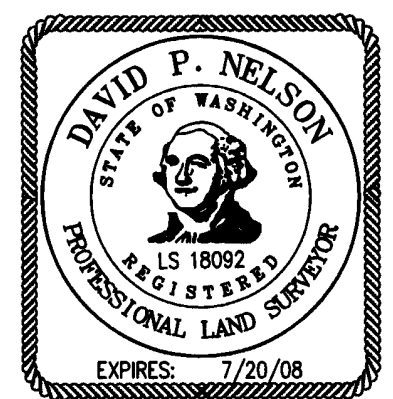
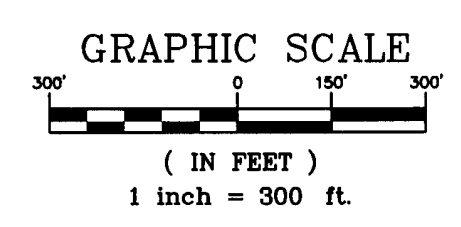

RECORDER'S CERTIFICATE 2006/03/0051  
 Filed for record this 21st day of Dec. 2006 at 4:25 P.M. in book 23 of Surveys at page 176 at the request of DAVID P. NELSON, Surveyor's Name.  
 JERALD V. PETTIT, County Auditor

SURVEYOR'S CERTIFICATE  
 This map correctly represents a survey made by me or under my direction in conformance with the requirements of the Survey Recording Act at the request of LAURIN MELLERGAARD in... DEC. 2006.  
 DAVID P. NELSON, Surveyor's Name  
 Certificate No. 18092

**Encompass**  
 ENGINEERING & SURVEYING  
 108 EAST 2ND STREET  
 CLE ELUM, WA 98922  
 PHONE: (509) 674-7433  
 FAX: (509) 674-7419

SEGREGATION/BOUNDARY LINE ADJUSTMENT  
 PREPARED FOR LAURIN MELLERGAARD  
 PORTIONS OF THE E 1/2 OF SEC. 17 & THE W 1/2 OF SEC. 16 TOWNSHIP 17 NORTH, RANGE 18 EAST, W.M. WASHINGTON

DWN BY	DATE	JOB NO.
M. FAIOLA	12/2006	03656
CHKD BY	SCALE	SHEET
D. NELSON	1"=300'	6 OF 7

# SEGREGATION / BOUNDARY LINE ADJUSTMENT SURVEY

## PORTIONS OF SECTION 16 & 17, TOWNSHIP 17 NORTH, RANGE 18 EAST, W.M., KITITITAS COUNTY, WASHINGTON.

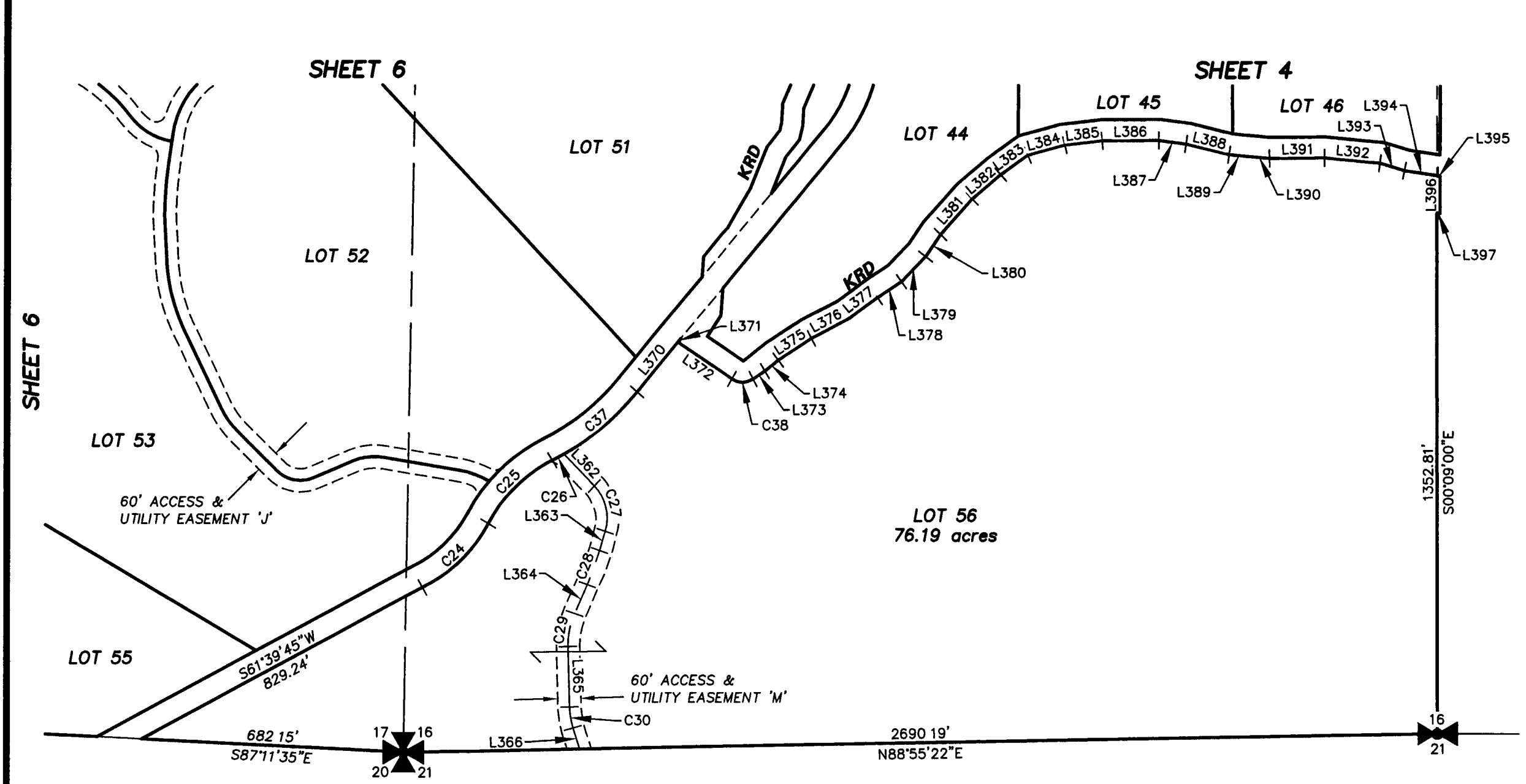

LINE TABLE			LINE TABLE			CURVE TABLE			
LINE	LENGTH	BEARING	LINE	LENGTH	BEARING	CURVE	LENGTH	RADIUS	DELTA
L362	114.41	S43°53'58"E	L384	99.78	N74°33'00"E	C24	241.45	382.46	36°10'15"
L363	52.00	S16°27'58"W	L385	98.36	N83°14'00"E	C25	237.51	378.63	35°56'30"
L364	81.80	S23°39'56"W	L386	147.52	N89°39'00"E	C26	34.00	669.36	2°54'37"
L365	156.57	S01°26'35"E	L387	70.52	S82°35'00"E	C27	126.43	120.00	60°21'56"
L366	56.87	S17°17'43"E	L388	115.37	S76°11'00"E	C28	94.24	750.00	7°11'58"
L370	179.46	N39°13'04"E	L389	52.76	S84°43'00"E	C29	87.65	200.00	25°06'30"
L371	12.32	S32°36'00"W	L390	52.78	S84°43'00"E	C30	55.33	200.00	15°51'08"
L372	168.80	S55°39'00"E	L391	143.00	N89°26'00"E				
L373	36.76	N55°41'00"E	L392	145.88	S84°43'00"E				
L374	44.80	N50°47'00"E	L393	66.46	S72°43'00"E				
L375	103.03	N56°48'00"E	L394	88.14	S81°38'00"E				
L376	111.71	N62°02'00"E	L395	5.98	S73°32'00"E				
L377	91.99	N52°46'00"E	L396	97.48	S00°00'52"W				
L378	75.64	N56°22'00"E	L397	8.00	N89°16'43"W				
L379	91.04	N43°24'00"E							
L380	69.35	N33°18'00"E							
L381	125.18	N41°23'00"E							
L382	97.87	N49°26'00"E							
L383	86.57	N53°35'00"E							

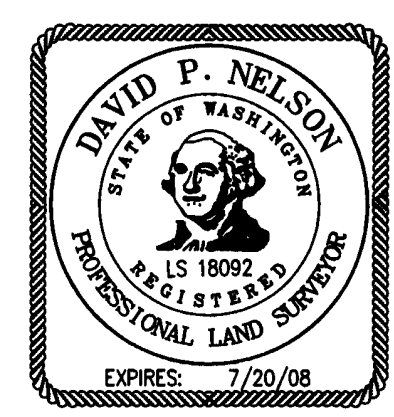

### LEGEND

- SECTION CORNER COMMON TO FOUR SECTIONS
- QUARTER CORNER COMMON TO TWO SECTIONS

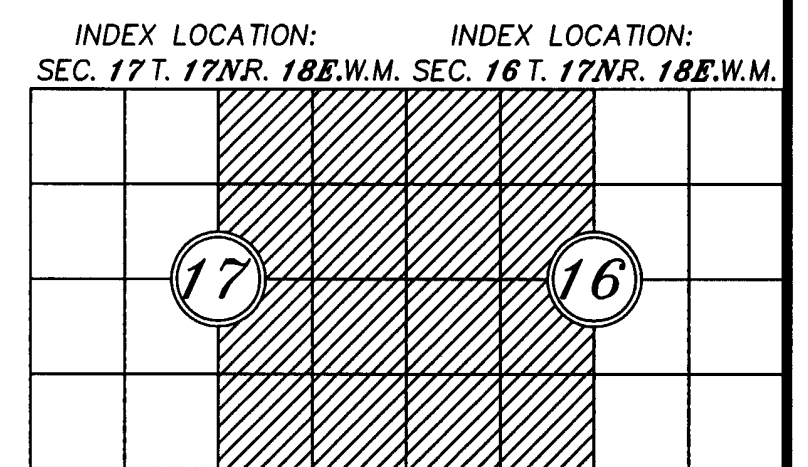
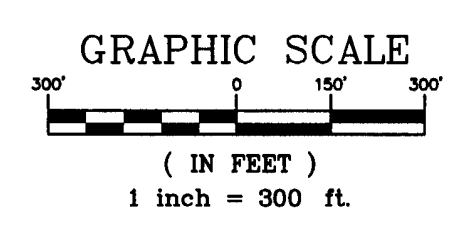

RECORDER'S CERTIFICATE 200612210051  
Filed for record this 21st day of Dec. 2006 at 4:25 P.M. in book 33 of Surveys at page 171 at the request of DAVID P. NELSON, Surveyor's Name.  
JERALD V. PETTIT, County Auditor

SURVEYOR'S CERTIFICATE  
This map correctly represents a survey made by me or under my direction in conformance with the requirements of the Survey Recording Act at the request of LAURIN MELLERGAARD in DEC. 2006.  
DAVID P. NELSON, Surveyor's Name  
Certificate No. 18092

**Encompass**  
ENGINEERING & SURVEYING  
108 EAST 2ND STREET  
CLE ELUM, WA 98922  
PHONE: (509) 674-7433  
FAX: (509) 674-7419

SEGREGATION/BOUNDARY LINE ADJUSTMENT  
PREPARED FOR LAURIN MELLERGAARD  
PORTIONS OF SEC. 16 & 17  
TOWNSHIP 17 NORTH, RANGE 18 EAST, W.M.  
KITITITAS COUNTY WASHINGTON  
DWN BY M. FAIOLA DATE 12/2006 JOB NO. 03656  
CHKD BY D. NELSON SCALE 1"=300' SHEET 7 OF 7